

Pellet Inserts



HARMAN[®]

BY FORGE & FLAME

Harman Pellet Inserts

Packed with exclusive technologies, Harman pellet inserts give you the most powerful and easy pellet heating experience. The PelletPro, ESP, EASY Touch Control, and Wireless Room Sensor work in harmony to burn any grade of pellet with high efficiency and the smartest, most accurate temperature control and lowest maintenance.

Designed with true engineering excellence, Harman pellet inserts are built with our uncompromising commitment to quality and standard features that are worth the investment.

Features

- Smart operation with EASY Touch Control and Wireless Room Sensor
- Save money with built-in programmable thermostat
- View fuel levels easily with illuminated glass hopper lid
- Burn any grade of pellet fuel
- Less loading with up to 64.5-lb hopper capacity
- Easy, low maintenance
- Elegant flame-reactive mirrored glass



Above: Accentra52i-TC shown in Porcelain Majolica Brown
Cover image: Accentra52i-TC shown in Matte Black



P42i-TC shown with optional surround extension



Accentra52i-TC

Specifications

BTU/Hr Input¹..... 11,200 – 50,300
 Efficiency²..... 81% LHV; 76% HHV
 Emissions..... 1.1 g/hr
 Heating Capacity³..... 900-2,600 sq ft
 Fuel Type..... Pellet
 Weight..... 460 lb

Hopper Capacity:
 20" fireplace opening: 47.5 lb
 24" fireplace opening: 64.5 lb
 Feed Rate: 1.5-5.8 lb/hr
 Venting Size⁴: 4"

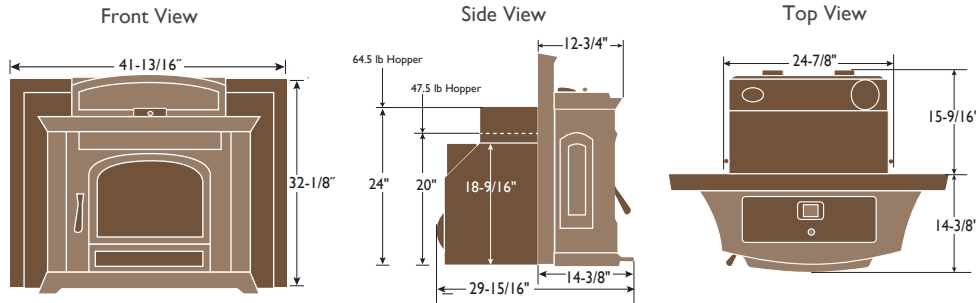

Clearance to Combustibles

- A. Unit to sidewall..... 12"
- B. Unit top to mantel 12"
- C. Cast surround top to 3/4" trim.....0"
- D. Cast surround side to 3/4" trim.....0"
- E. Floor protector: spark and ember protection only (from glass)6"

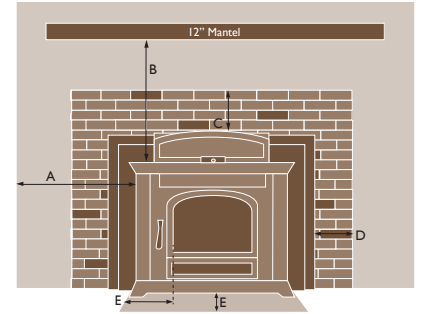

Floor Protection: Minimum: 30"Wx 16-1/2"D

P42i-TC

Specifications

BTU/Hr Input¹..... 7,400-41,800
 Efficiency²..... 84% LHV; 79% HHV
 Emissions..... 1.0 g/hr
 Heating Capacity³..... 800-2,400 sq ft
 Fuel Type..... Pellet
 Weight..... 412 lb

Hopper Capacity:
 20" fireplace opening: 47.5 lb
 24" fireplace opening: 64.5 lb
 Feed Rate: .93-5.3 lb/hr
 Venting Size⁴: 4"

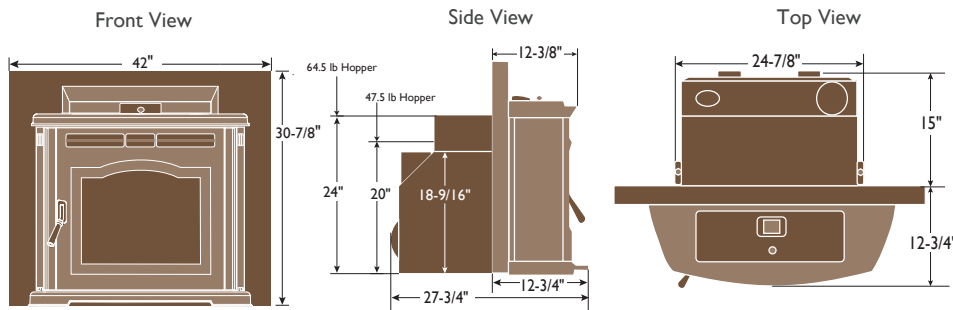



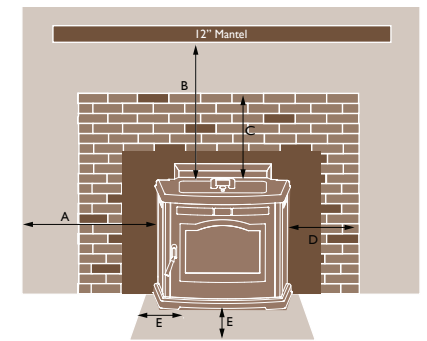

Clearance to Combustibles

- A. Unit to sidewall..... 12"
- B. Unit top to mantel 12"
- C. Steel surround top to 3/4" trim0"
- D. Steel surround side to 3/4" trim0"
- E. Floor protector: spark and ember protection only (from glass)6"



Floor Protection: Minimum: 30"W x 17"D

Pellet insert technologies

-  **E.A.S.Y. Touch Control** Easy. Accurate. Smart. Yearly Savings.—The Harman EASY Touch Control is the most advanced control system ever created and makes it easy to operate your insert, maintain accurate temperatures all day, every day, monitor performance and be notified when maintenance is needed, and save money on heating bills every year.
-  **PelletPro™ Technology** Burn any grade of pellet fuel with maximum heat and efficiency with this patented system. A bottom-up feed system burns each pellet completely and allows for 24-hour heating.
-  **ESP Temperature Control** Exhaust Sensing Probe (ESP) system delivers precise heat control, constantly monitoring and adjusting heat output to maintain set room temperatures within one degree.
-  **Wireless Room Sensor** Designed to communicate with the EASY Touch Controls on Harman pellet products from up to 30 feet away. Mounts on a wall wherever you want your heat measured.

Three easy steps to upgrade your existing wood-burning fireplace

STEP 1: MEASURE YOUR EXISTING FIREPLACE OPENING AND CHOOSE YOUR INSERT

The height, width and depth of the existing fireplace opening is needed to ensure selection of an appropriately-sized insert:

- A. Fireplace front width _____ D. Fireplace depth _____
 B. Fireplace front height _____ E. Hearth to mantel height _____
 C. Fireplace back width _____

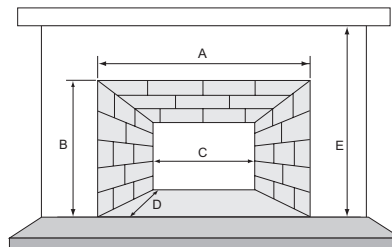

When choosing your model, keep these two factors in mind and you're sure to make a solid choice:

- Consider the size of your existing fireplace opening – try and fill that space
- Consider how your insert will be used: room size, heating needs and usage frequency all come into play

STEP 2: CHOOSE YOUR SURROUND

Surrounds fill the gap between the fireplace insert and existing fireplace opening. Both the Accentra52i-TC and the P42i-TC come standard with the small surround. Choose the surround extension (48" w x 36" h) if you need the larger size, or custom sizes are available (up to 60" w x 47" h).

STEP 3: CUSTOMIZE YOUR INSERT



Choose Matte Black or
Majolica Brown Porcelain finish (Accentra52i-TC only)



Ceramic Log Kit



Service Rail Kit



Outside Temperature Kit

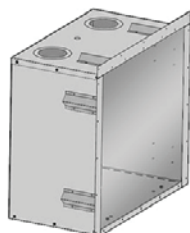

Zero Clearance Cabinet
(used to install where there is not a factory built fireplace or masonry fireplace)



Direct Vent Wall Pass-Through





Outside Air Termination Cap

Your Harman dealer is:

HARMAN[®]
BY FORGE & FLAME

PHONE: 800-664-3119
WWW.HARMANSTOVES.COM

 facebook.com/HarmanStoves
 youtube.com/HarmanStoves

HAR-1715U-0823

LIMITED LIFETIME WARRANTY⁶

The strongest in the industry, Harman provides a limited lifetime warranty on most important aspects: firebox and heat exchanger.

¹EPA tested input ²Weighted average LHV (Low Heating Value) efficiency. HHV (High Heat Value) efficiency used to qualify products for Tax Credit beginning in 2021. ³See your local authorized Harman dealer for help in determining the product that best suits your heating needs based on climate and home efficiency. ⁴When using 3" PL vent pipe, there must be 3" clearance to combustibles. ⁵For full warranty details, visit www.harmanstoves.com.

Actual product appearance, including flame, may differ from image. Product specifications and pricing subject to change without notice. The images and descriptions in this brochure are provided to assist you in product selection only. Fuel density and pellet shape may affect hopper capacity. BTUs may vary depending on type of fuel used. Refer to installation manual for complete clearance requirements and specifications.

Appliance surfaces get extremely HOT and can cause severe burns if touched. Keep a safe distance away. To learn more visit www.harmanstoves.com/fireplacesafety